

MN145/17

DARWIN

31 October 2017

Mineral Titles Act

NOTICE OF LAND CEASING TO BE A MINERAL TITLE

Title Type and Number: Extractive Mineral Permit 31652
 Area ceased on: 30 October 2017
 Area: 3.00 Hectare
 Locality: MOUNT PEAKE
 Name of Applicant(s)/Holder(s): 100% NORTH CONCRETE (NT) PTY LTD [ACN. 128 802 997]

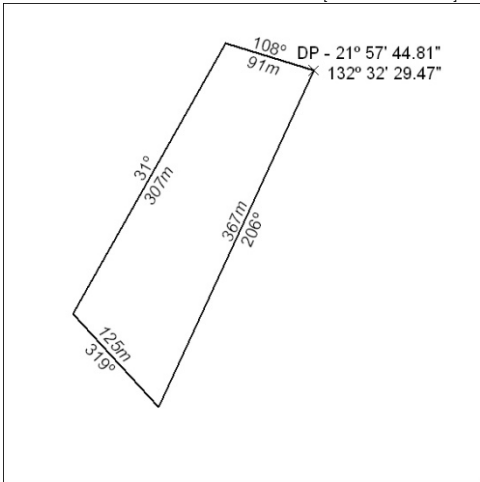

513/17

Mineral Titles Act

NOTICE OF LAND CEASING TO BE A MINERAL TITLE AREA

Title Type and Number: Exploration Licence 24900
 Area Ceased on: 31 October 2017
 Area: 238 Blocks, 735.98 sq kms
 Locality: FINKE
 Name of Applicant(s)/Holder(s): 100% TRI-STAR ENERGY COMPANY [ACN. 089 539 695]

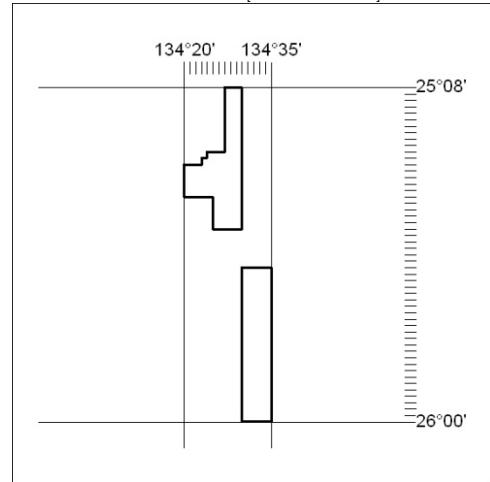

515/17

Mineral Titles Act

NOTICE OF LAND CEASING TO BE A MINERAL TITLE AREA

Title Type and Number: Exploration Licence 24899
 Area Ceased on: 31 October 2017
 Area: 195 Blocks, 603.86 sq kms
 Locality: BEDDOME
 Name of Applicant(s)/Holder(s): 100% TRI-STAR ENERGY COMPANY [ACN. 089 539 695]

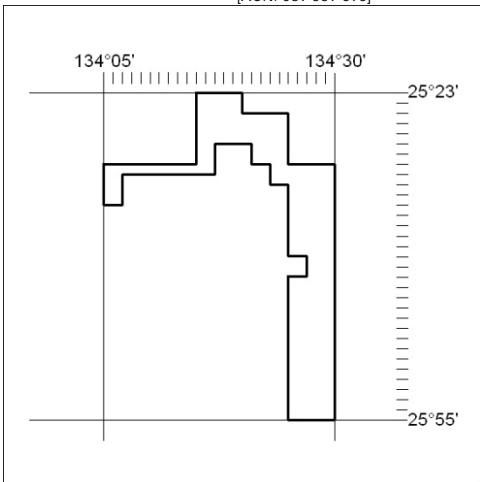

514/17

Mineral Titles Act

NOTICE OF LAND CEASING TO BE A MINERAL TITLE AREA

Title Type and Number: Exploration Licence 24901
 Area Ceased on: 31 October 2017
 Area: 250 Blocks, 773.03 sq kms
 Locality: MUSGRAVE
 Name of Applicant(s)/Holder(s): 100% TRI-STAR ENERGY COMPANY [ACN. 089 539 695]

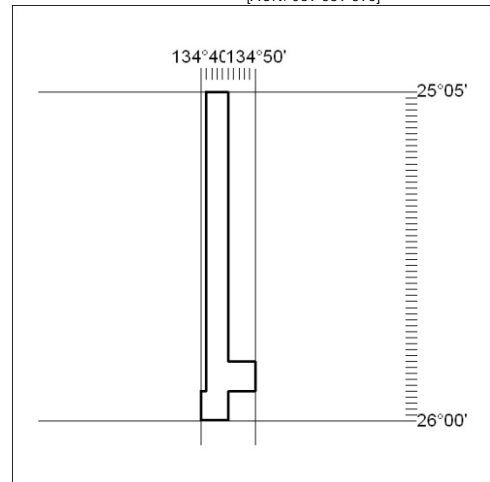

516/17

MN145/17

DARWIN

31 October 2017

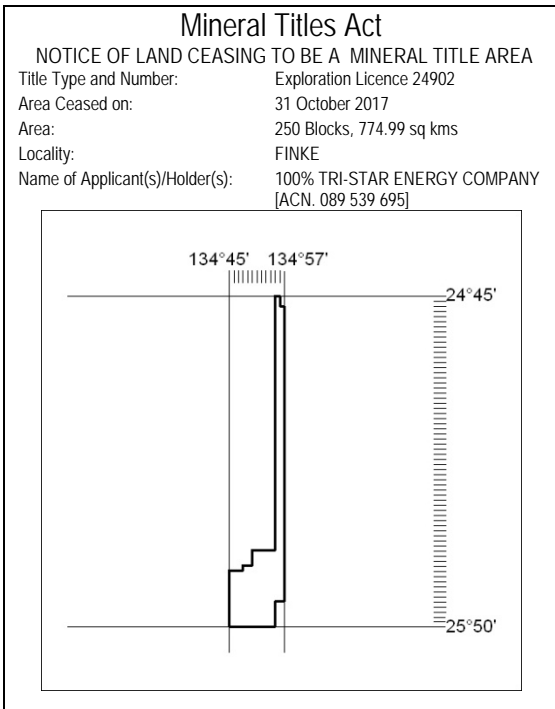

517/17

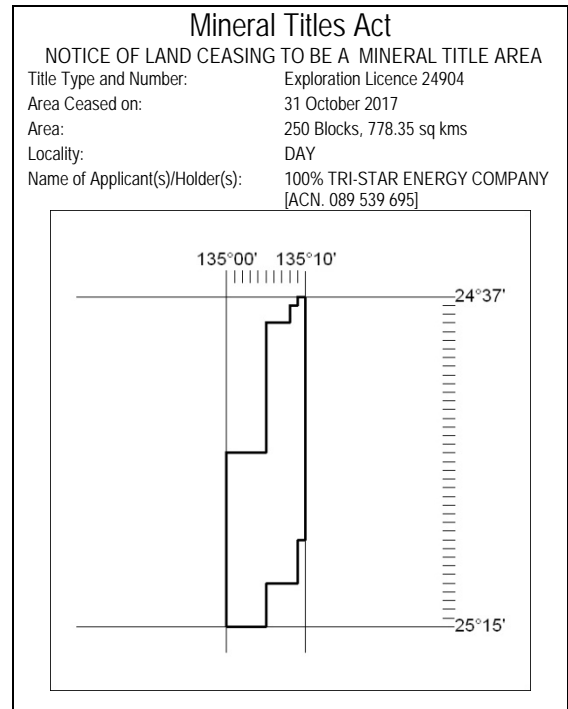

519/17

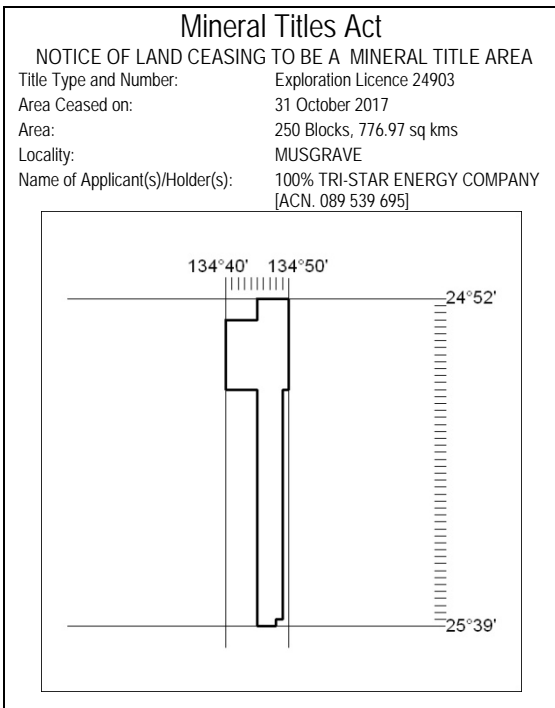

518/17

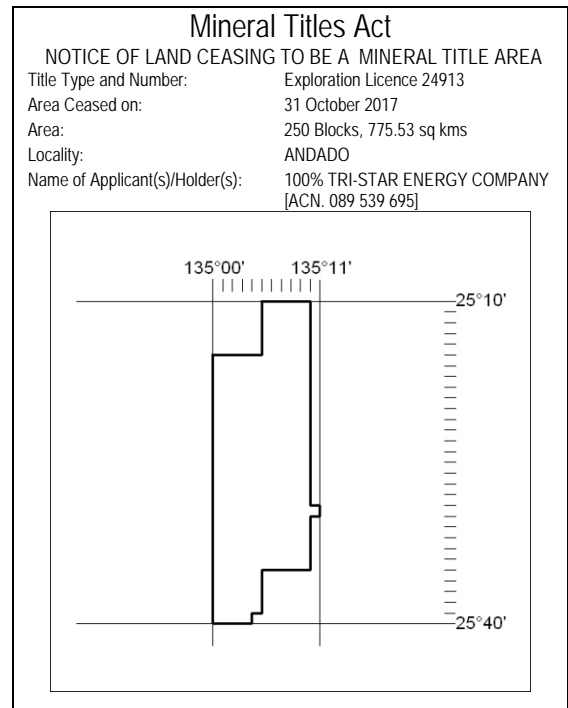

520/17

MN145/17

DARWIN

31 October 2017

Mineral Titles Act

NOTICE OF LAND CEASING TO BE A MINERAL TITLE AREA

Title Type and Number: Exploration Licence 24914
 Area Ceased on: 31 October 2017
 Area: 217 Blocks, 675.27 sq kms
 Locality: POODINITERRA
 Name of Applicant(s)/Holder(s): 100% TRI-STAR ENERGY COMPANY [ACN. 089 539 695]

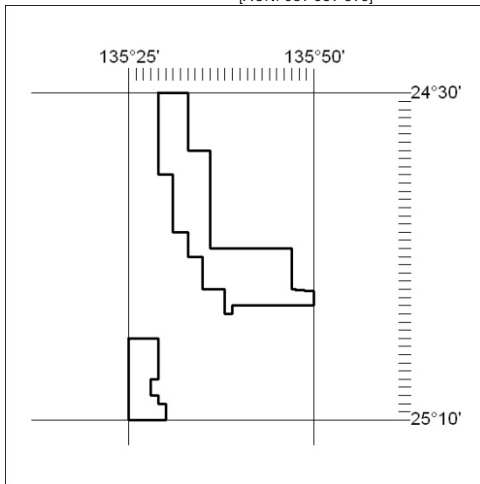

521/17

Mineral Titles Act

NOTICE OF LAND CEASING TO BE A MINERAL TITLE AREA

Title Type and Number: Exploration Licence 26708
 Area Ceased on: 30 October 2017
 Area: 31 Blocks, 99.74 sq kms
 Locality: HANLON
 Name of Applicant(s)/Holder(s): 100% KETTLE ROSE PTY LTD [ACN. 119 016 330]

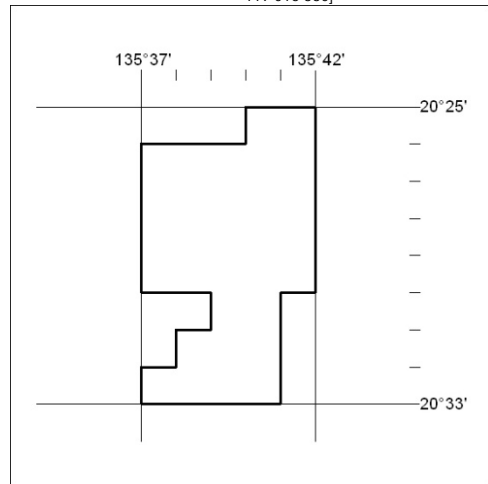

523/17

Mineral Titles Act

NOTICE OF LAND CEASING TO BE A MINERAL TITLE AREA

Title Type and Number: Exploration Licence 26045
 Area Ceased on: 31 October 2017
 Area: 237 Blocks, 739.00 sq kms
 Locality: DAY
 Name of Applicant(s)/Holder(s): 100% TRI-STAR ENERGY COMPANY [ACN. 089 539 695]

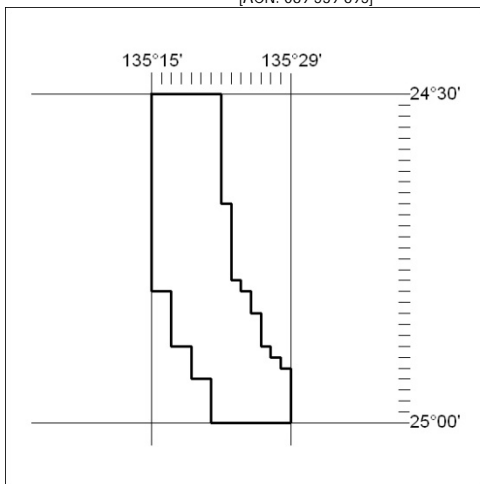

522/17

Mineral Titles Act

NOTICE OF LAND CEASING TO BE A MINERAL TITLE AREA

Title Type and Number: Exploration Licence 27219
 Area Ceased on: 31 October 2017
 Area: 17 Blocks, 52.80 sq kms
 Locality: UMBEARA
 Name of Applicant(s)/Holder(s): 100% TRI-STAR ENERGY COMPANY [ACN. 089 539 695]

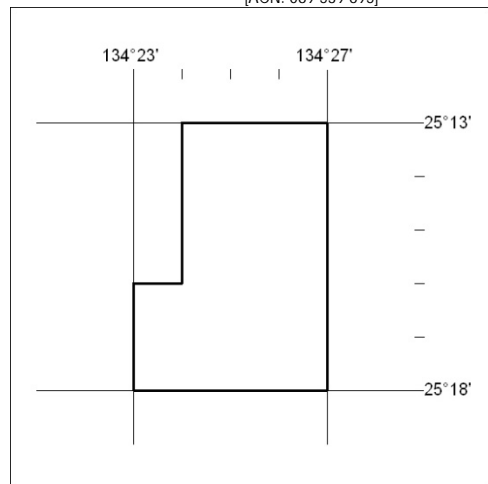

524/17

MN145/17

DARWIN

31 October 2017

Mineral Titles Act

NOTICE OF LAND CEASING TO BE A MINERAL TITLE AREA

Title Type and Number: Exploration Licence 27347
 Area Ceased on: 31 October 2017
 Area: 294 Blocks, 899.25 sq kms
 Locality: BEDDOME
 Name of Applicant(s)/Holder(s): 100% TRI-STAR ENERGY COMPANY [ACN. 089 539 695]

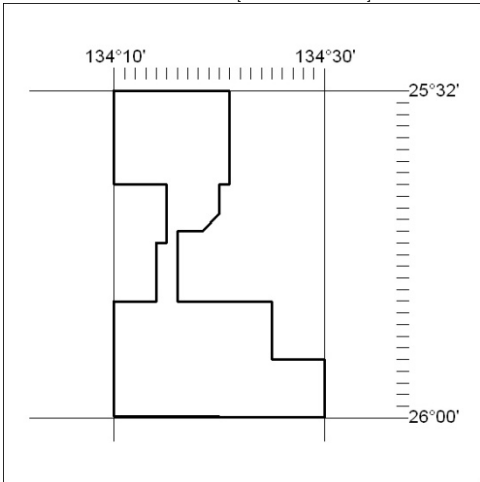

525/17

Mineral Titles Act

NOTICE OF LAND CEASING TO BE A MINERAL TITLE AREA

Title Type and Number: Exploration Licence 29233
 Area Ceased on: 31 October 2017
 Area: 15 Blocks, 46.51 sq kms
 Locality: ANDADO
 Name of Applicant(s)/Holder(s): 100% TRI-STAR ENERGY COMPANY [ACN. 089 539 695]

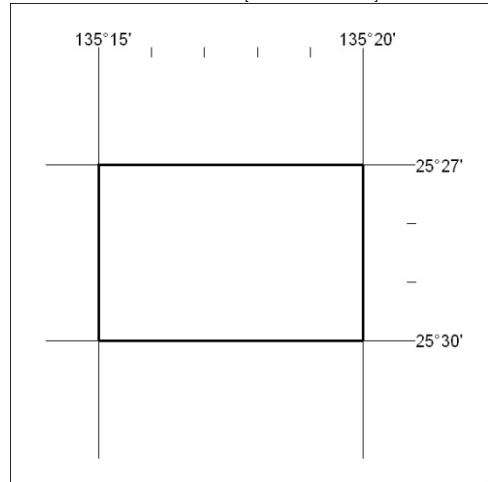

527/17

Mineral Titles Act

NOTICE OF LAND CEASING TO BE A MINERAL TITLE AREA

Title Type and Number: Exploration Licence 27348
 Area Ceased on: 31 October 2017
 Area: 17 Blocks, 52.65 sq kms
 Locality: BEDDOME
 Name of Applicant(s)/Holder(s): 100% TRI-STAR ENERGY COMPANY [ACN. 089 539 695]

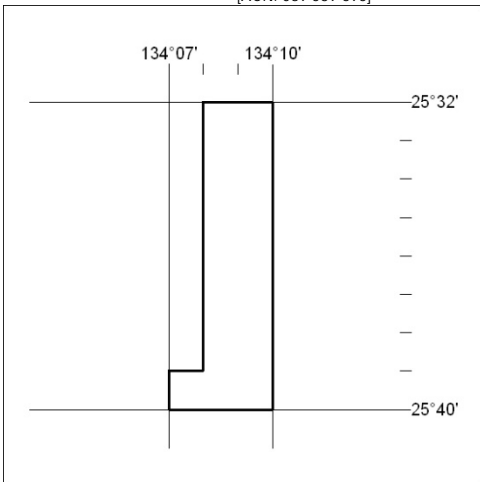

526/17

Mineral Titles Act

NOTICE OF LAND CEASING TO BE A MINERAL TITLE AREA

Title Type and Number: Exploration Licence 29234
 Area Ceased on: 31 October 2017
 Area: 201 Blocks, 622.22 sq kms
 Locality: McDILLS
 Name of Applicant(s)/Holder(s): 100% TRI-STAR ENERGY COMPANY [ACN. 089 539 695]

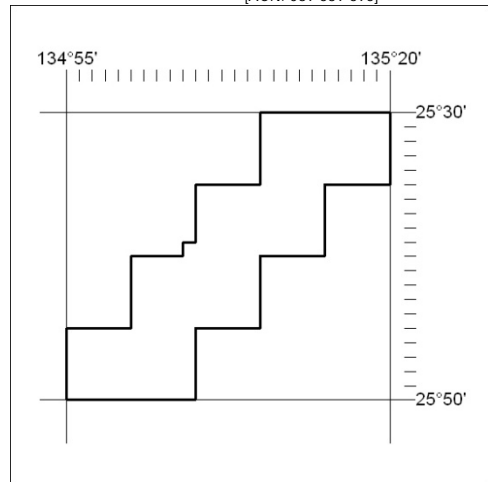

528/17

MN145/17

DARWIN

31 October 2017

Mineral Titles Act

NOTICE OF LAND CEASING TO BE A MINERAL TITLE AREA

Title Type and Number: Exploration Licence 29235
 Area Ceased on: 31 October 2017
 Area: 161 Blocks, 478.78 sq kms
 Locality: FINKE
 Name of Applicant(s)/Holder(s): 100% TRI-STAR ENERGY COMPANY [ACN. 089 539 695]

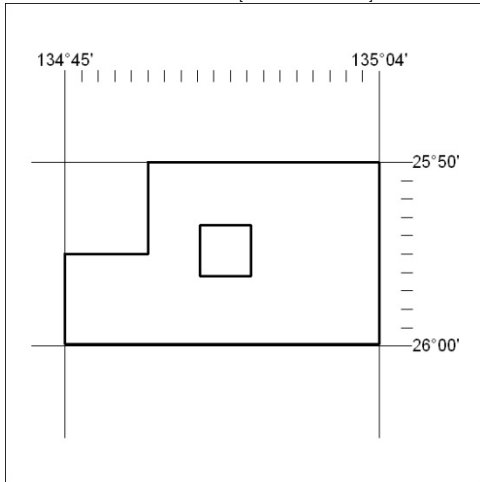

529/17

Mineral Titles Act

NOTICE OF LAND CEASING TO BE A MINERAL TITLE AREA

Title Type and Number: Exploration Licence 29702
 Area Ceased on: 31 October 2017
 Area: 250 Blocks, 776.60 sq kms
 Locality: ANDADO
 Name of Applicant(s)/Holder(s): 100% TRI-STAR ENERGY COMPANY [ACN. 089 539 695]

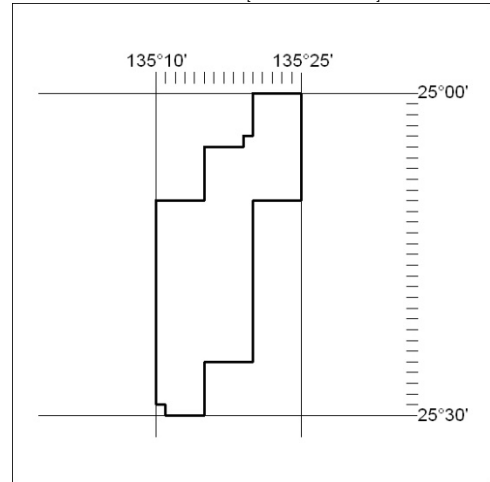

531/17

Mineral Titles Act

NOTICE OF LAND CEASING TO BE A MINERAL TITLE AREA

Title Type and Number: Exploration Licence 29685
 Area Ceased on: 31 October 2017
 Area: 105 Blocks, 292.65 sq kms
 Locality: POODINITERRA
 Name of Applicant(s)/Holder(s): 100% TRI-STAR ENERGY COMPANY [ACN. 089 539 695]

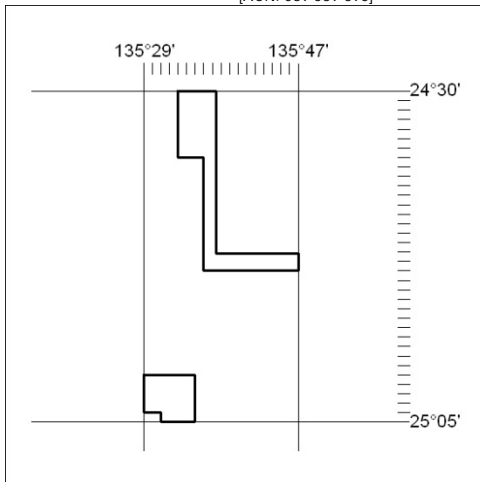

530/17

Mineral Titles Act

NOTICE OF LAND CEASING TO BE A MINERAL TITLE AREA

Title Type and Number: Exploration Licence 29703
 Area Ceased on: 31 October 2017
 Area: 250 Blocks, 776.66 sq kms
 Locality: MUSGRAVE
 Name of Applicant(s)/Holder(s): 100% TRI-STAR ENERGY COMPANY [ACN. 089 539 695]

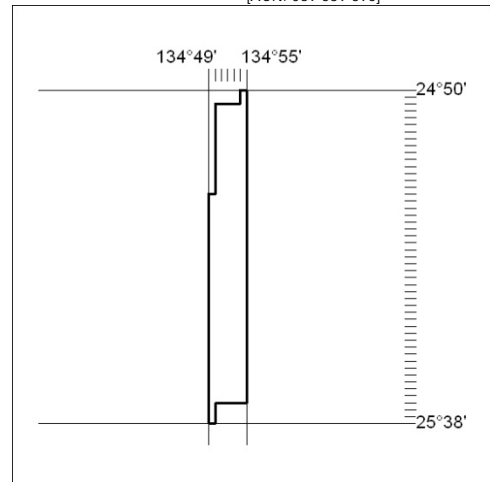

532/17

MN145/17

DARWIN

31 October 2017

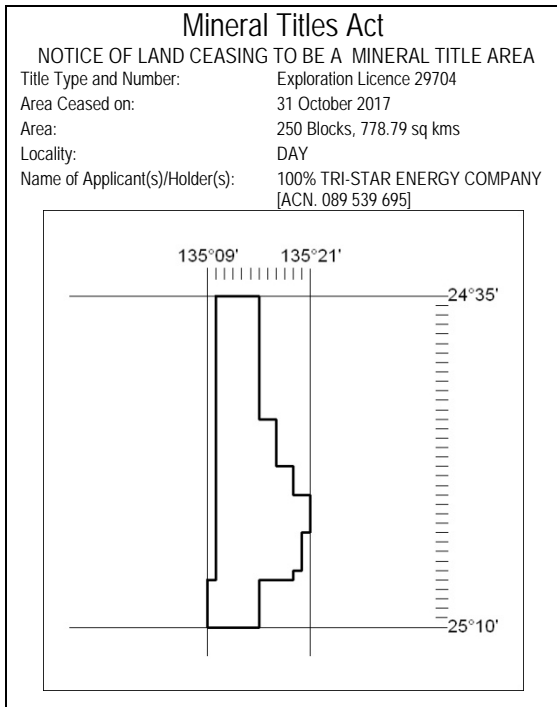

534/17

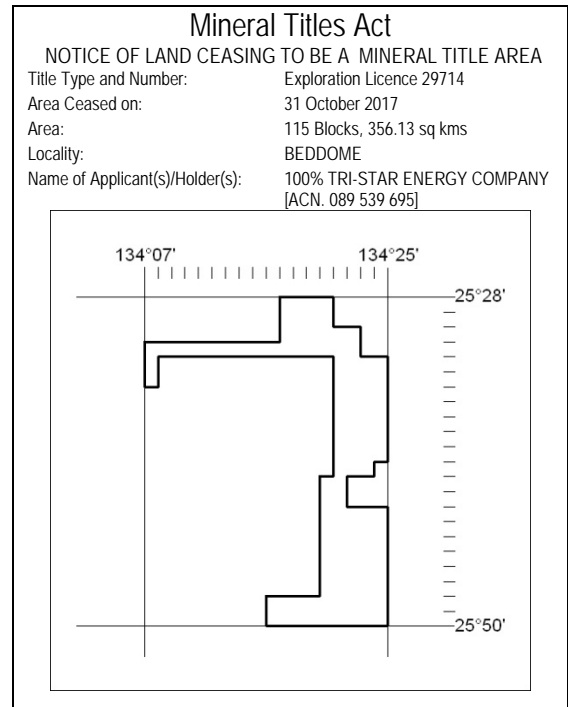

535/17

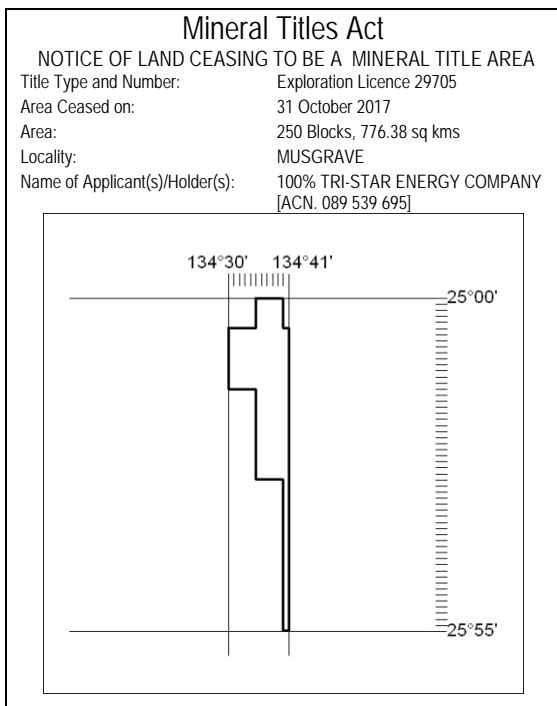

534/17

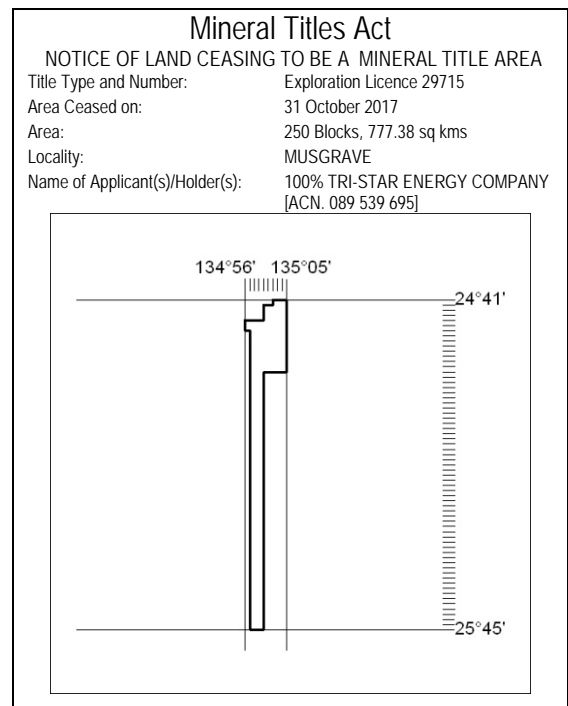

536/17

MN145/17

DARWIN

31 October 2017

Mineral Titles Act

NOTICE OF LAND CEASING TO BE A MINERAL TITLE AREA

Title Type and Number: Exploration Licence 29716
 Area Ceased on: 31 October 2017
 Area: 220 Blocks, 679.96 sq kms
 Locality: FINKE
 Name of Applicant(s)/Holder(s): 100% TRI-STAR ENERGY COMPANY
 [ACN. 089 539 695]

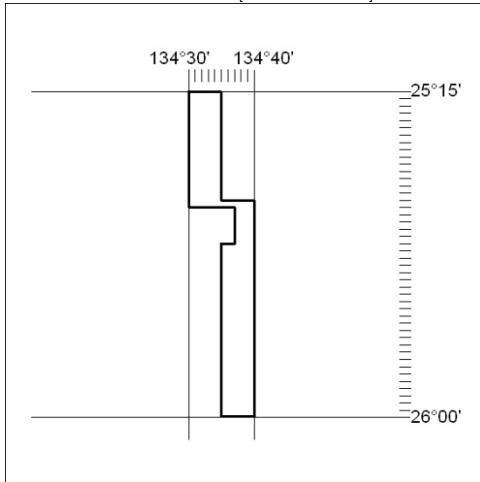

537/17

Mineral Titles Act

NOTICE OF LAND CEASING TO BE A MINERAL TITLE AREA

Title Type and Number: Exploration Licence 30639
 Area Ceased on: 31 October 2017
 Area: 241 Blocks, 751.61 sq kms
 Locality: DAY
 Name of Applicant(s)/Holder(s): 100% TRI-STAR ENERGY COMPANY
 [ACN. 089 539 695]

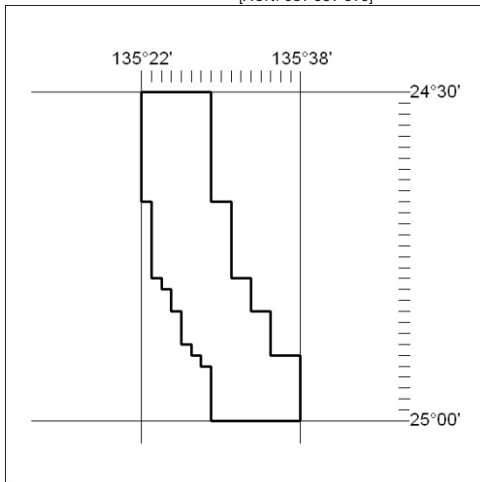

538/17