

MN124/18

DARWIN

3 October 2018

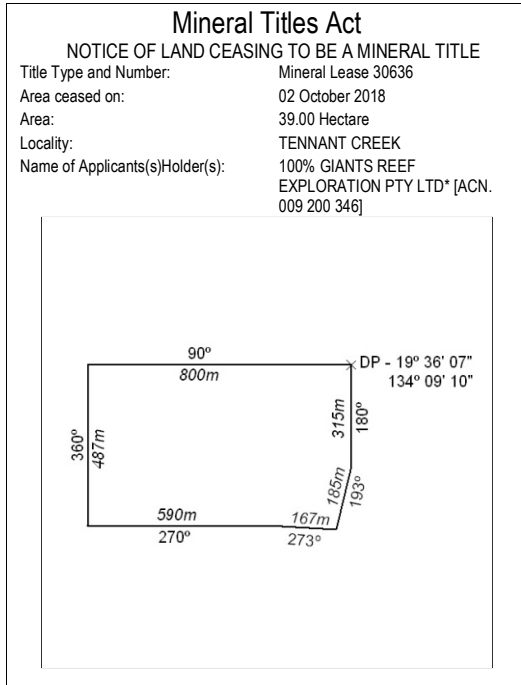

422/18

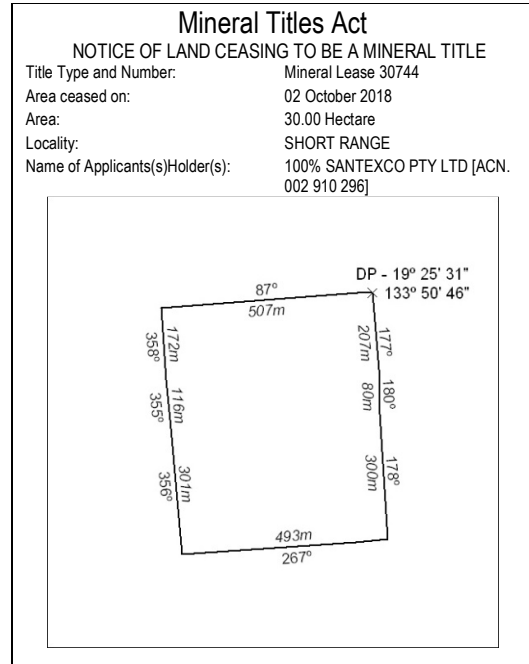

424/18

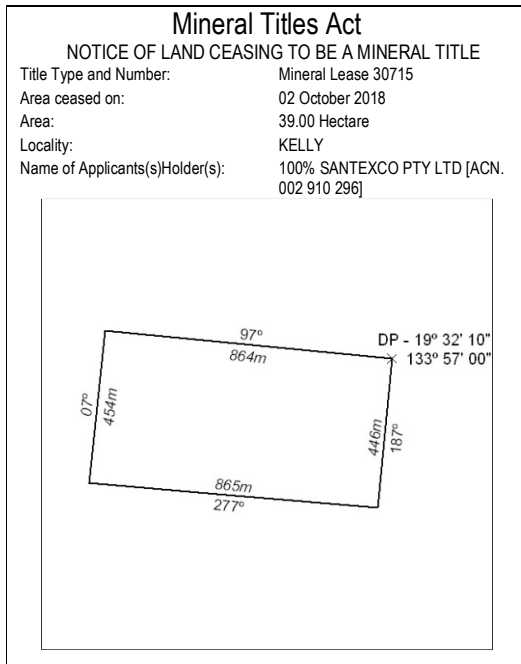

423/18

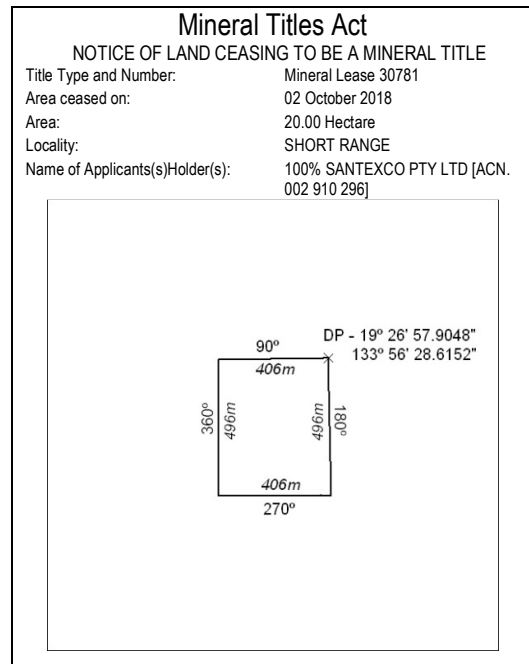

425/18

MN124/18

DARWIN

3 October 2018

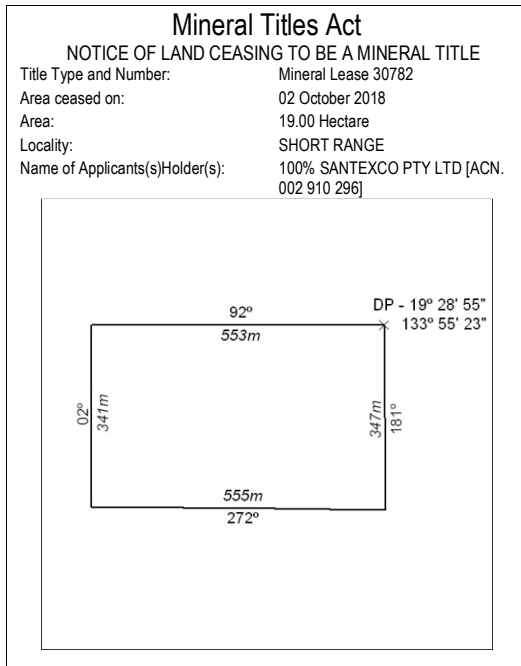

426/18

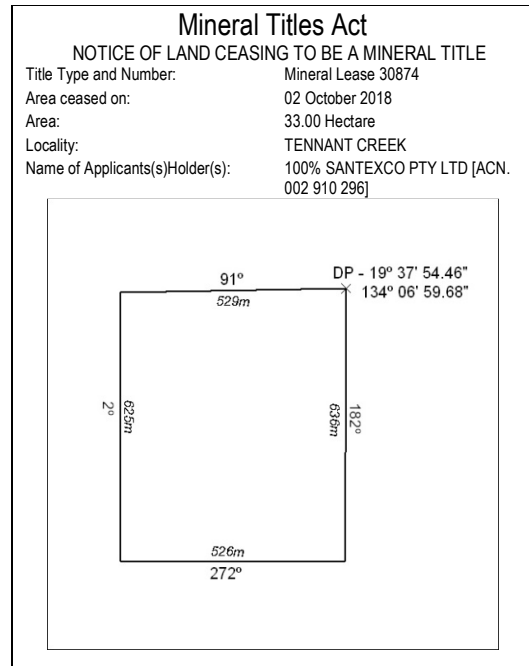

428/18

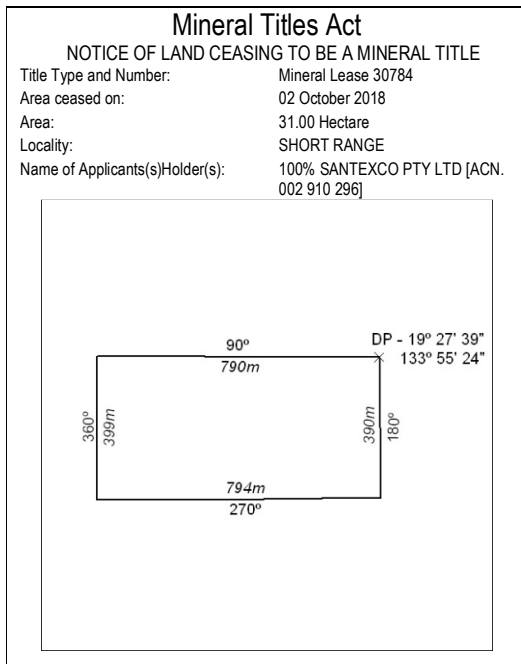

427/18

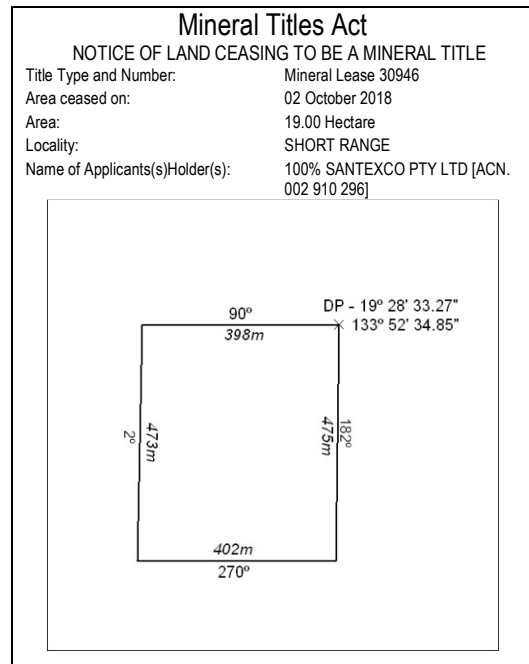

429/18

MN124/18

DARWIN

3 October 2018

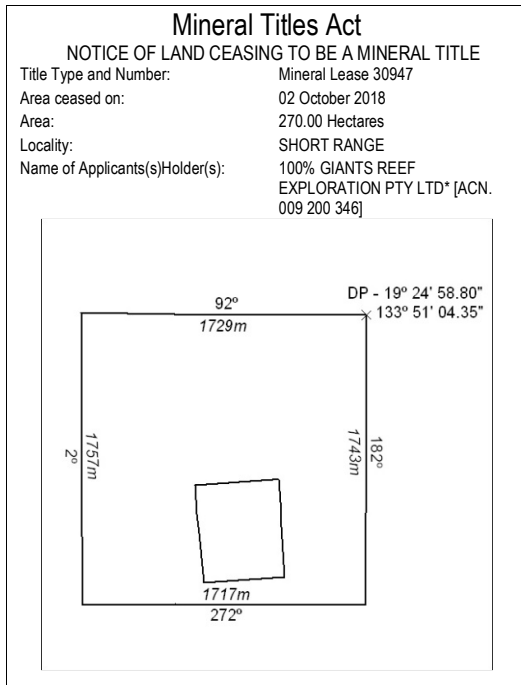

430/18

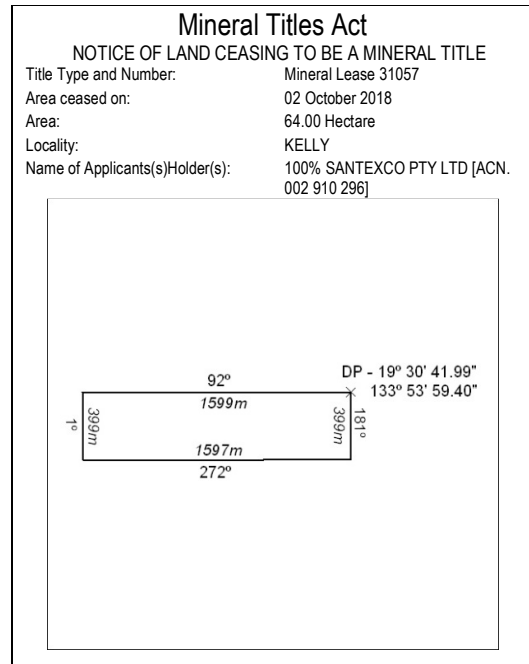

432/18

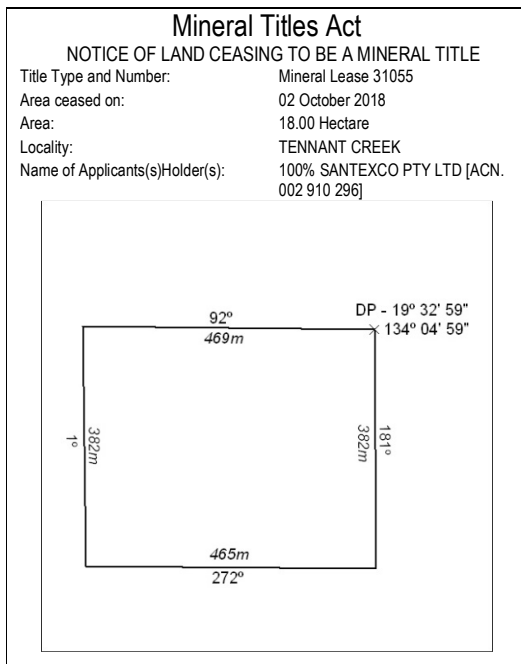

431/18

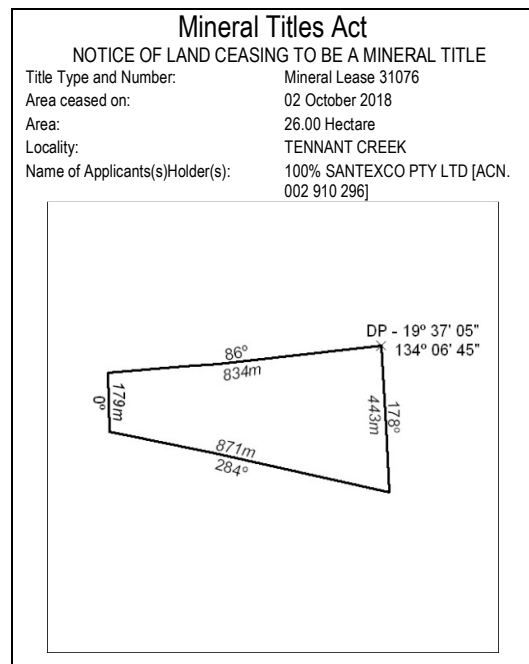

433/18

MN124/18

DARWIN

3 October 2018

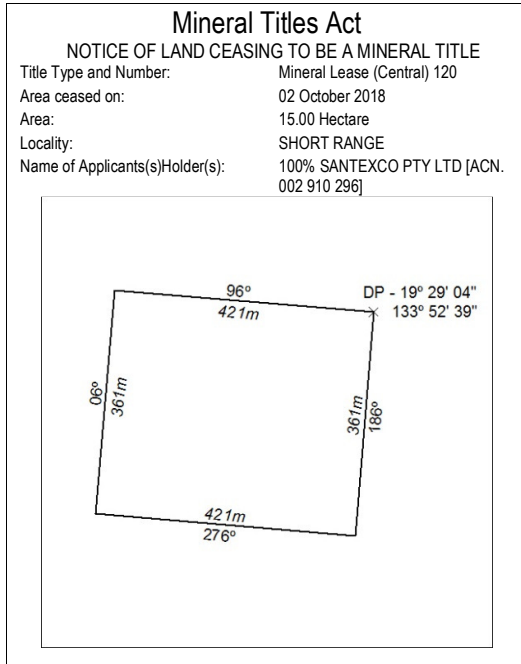

434/18

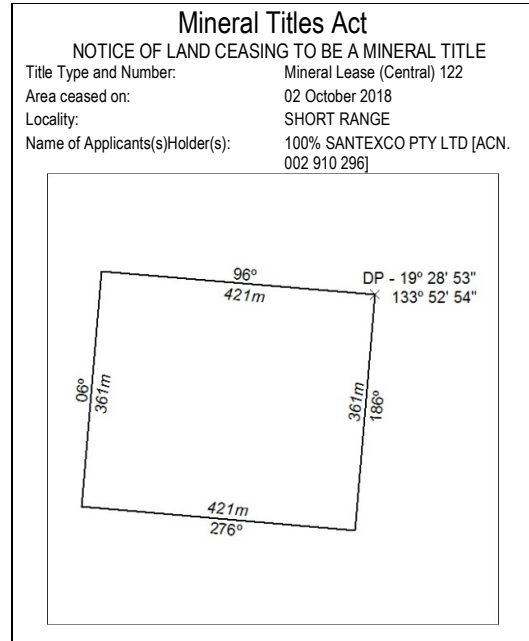

436/18

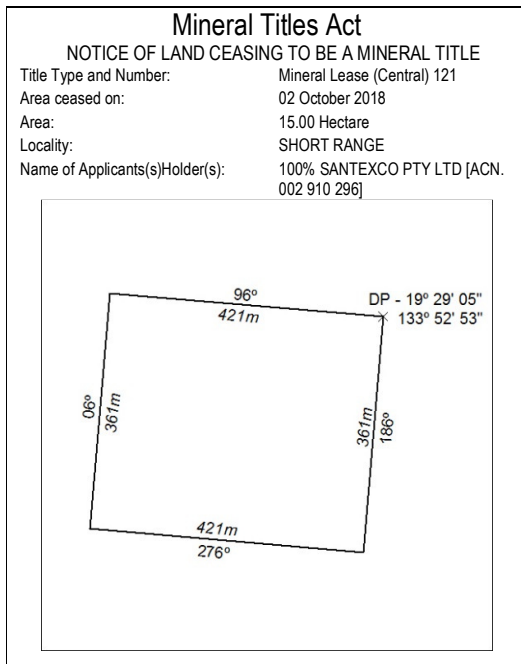

435/18

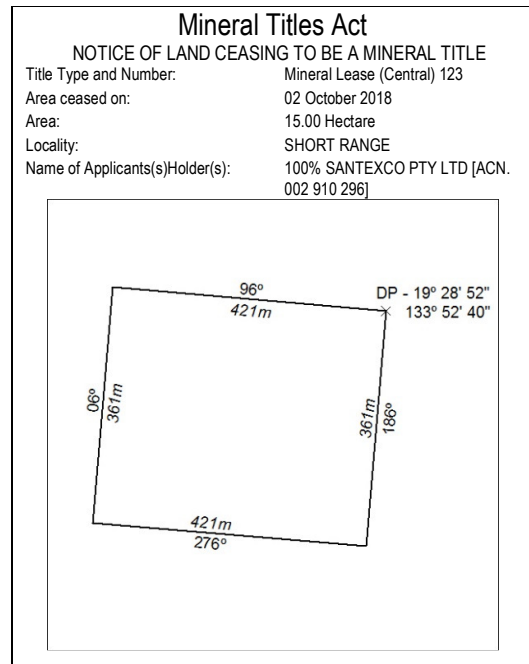

437/18

MN124/18

DARWIN

3 October 2018

Mineral Titles Act

NOTICE OF LAND CEASING TO BE A MINERAL TITLE

Title Type and Number: Mineral Lease (Central) 626
Area ceased on: 02 October 2018
Area: 8.00 Hectare
Locality: TENNANT CREEK
Name of Applicant(s)/Holder(s): 100% GIANTS REEF
EXPLORATION PTY LTD* [ACN.
009 200 346]

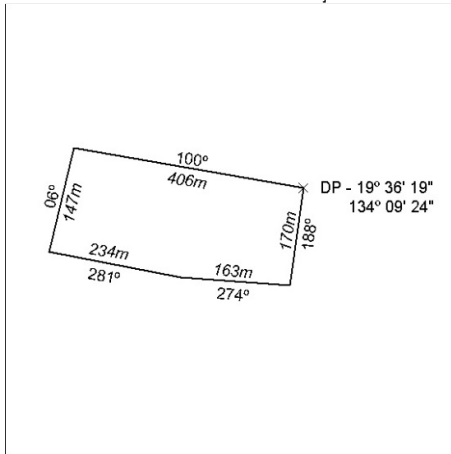

438/18