

Mineral Titles Act

NOTICE OF LAND CEASING TO BE A MINERAL TITLE AREA

Title Type and Number: Exploration Licence 27090
 Area Ceased on: 24 November 2015
 Area: 247 Blocks, 779.54 sq kms
 Locality: PLENTY DOWNS
 Name of Applicant(s)/Holder(s): 100% RED METAL LIMITED [ACN. 103 367 684]

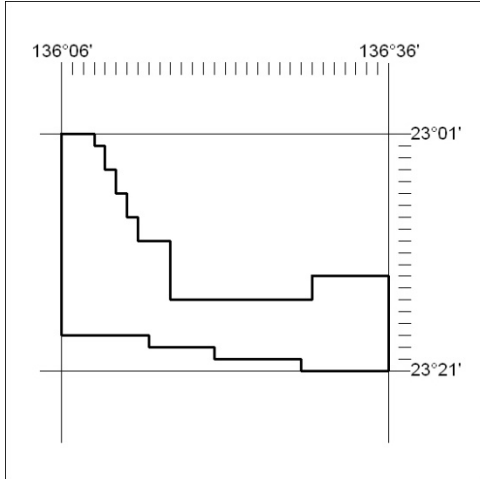

603/15

Mineral Titles Act

NOTICE OF LAND CEASING TO BE A MINERAL TITLE AREA

Title Type and Number: Exploration Licence 27100
 Area Ceased on: 24 November 2015
 Area: 476 Blocks, 1382.34 sq kms
 Locality: NUCKUA
 Name of Applicant(s)/Holder(s): 100% MERLIN COAL PTY LTD [ACN. 134 469 471]

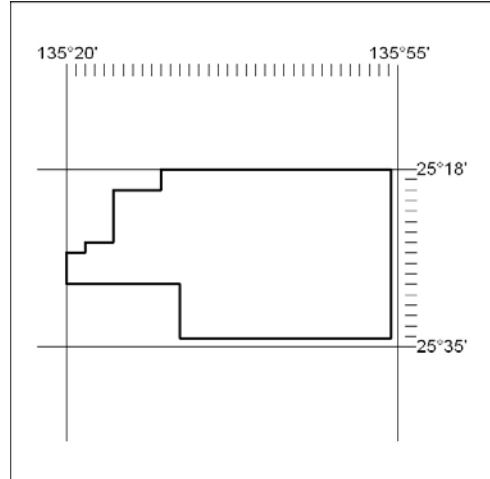

605/15

Mineral Titles Act

NOTICE OF LAND CEASING TO BE A MINERAL TITLE AREA

Title Type and Number: Exploration Licence 27094
 Area Ceased on: 24 November 2015
 Area: 47 Blocks, 97.81 sq kms
 Locality: McDILLS
 Name of Applicant(s)/Holder(s): 100% MERLIN COAL PTY LTD [ACN. 134 469 471]

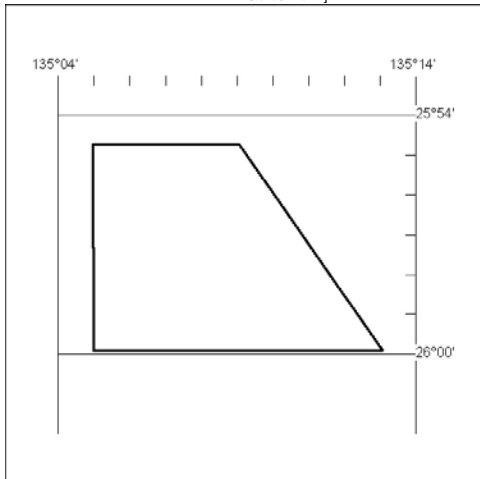

604/15

Mineral Titles Act

NOTICE OF LAND CEASING TO BE A MINERAL TITLE AREA

Title Type and Number: Exploration Licence 27101
 Area Ceased on: 24 November 2015
 Area: 255 Blocks, 735.41 sq kms
 Locality: NUCKUA
 Name of Applicant(s)/Holder(s): 100% MERLIN COAL PTY LTD [ACN. 134 469 471]

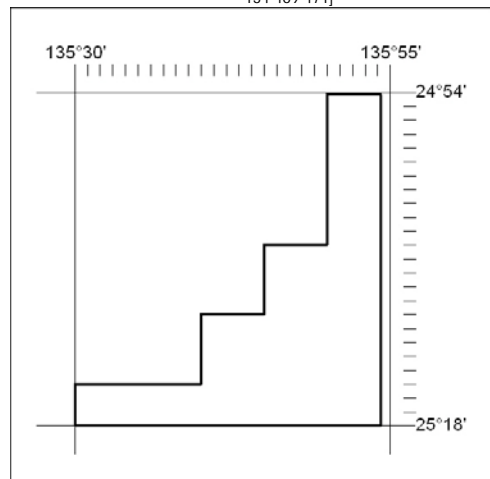

606/15

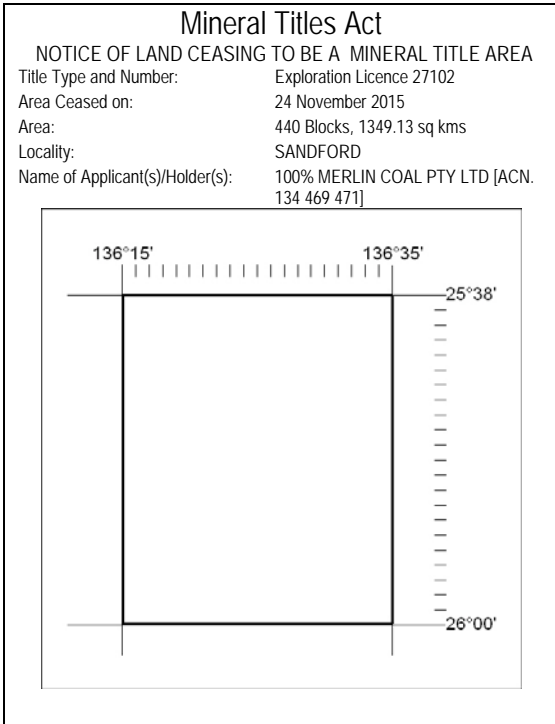

607/15

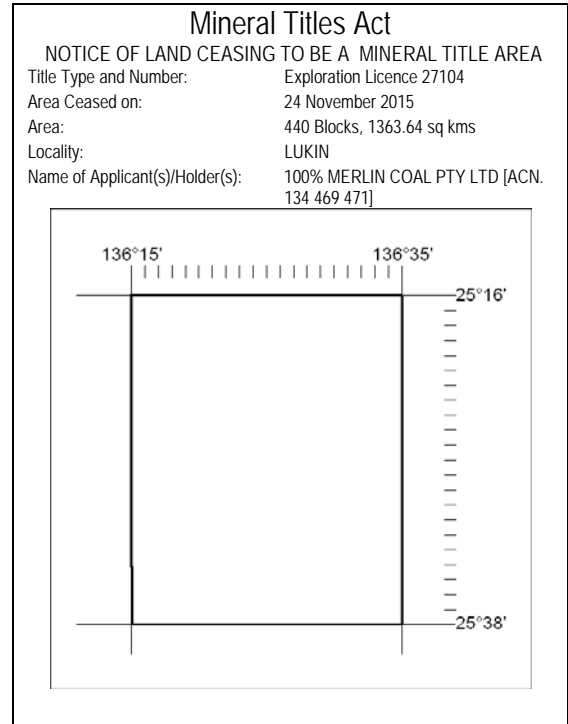

609/15

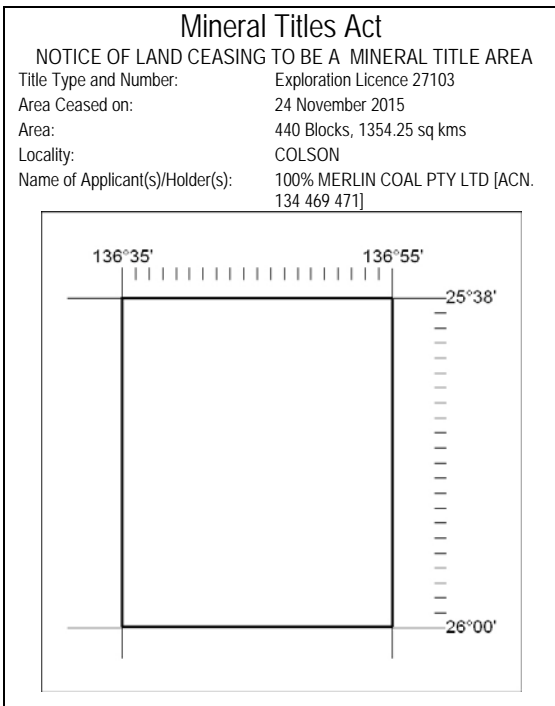

608/15

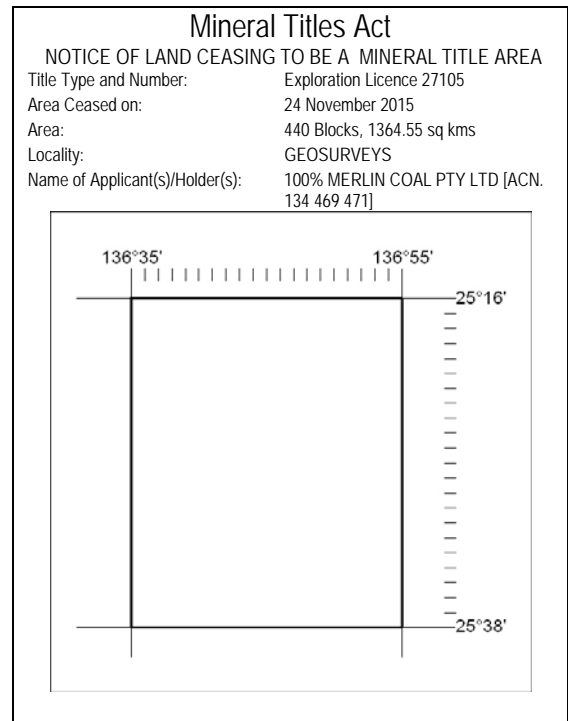

610/15

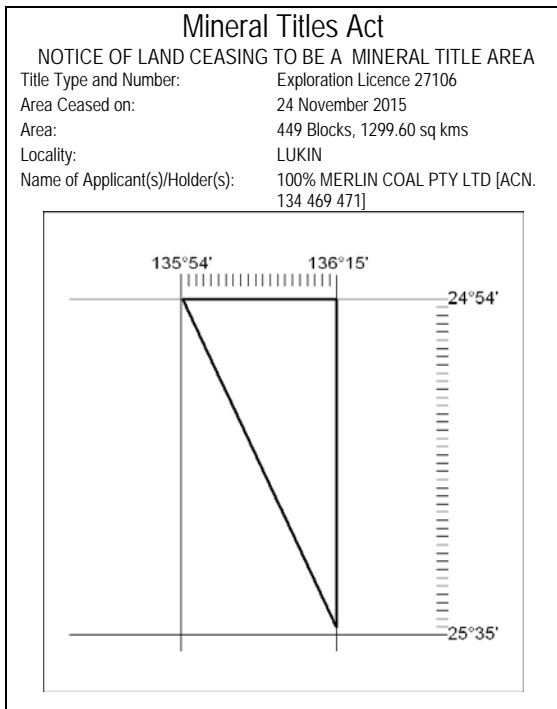

611/15

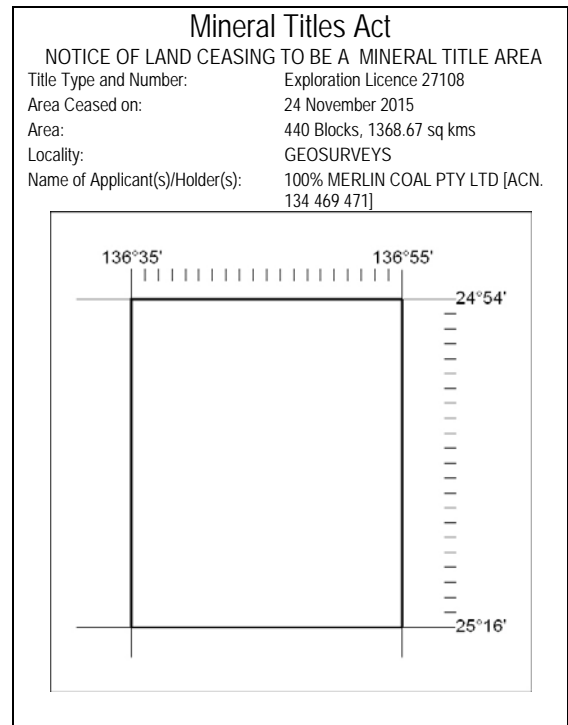

613/15

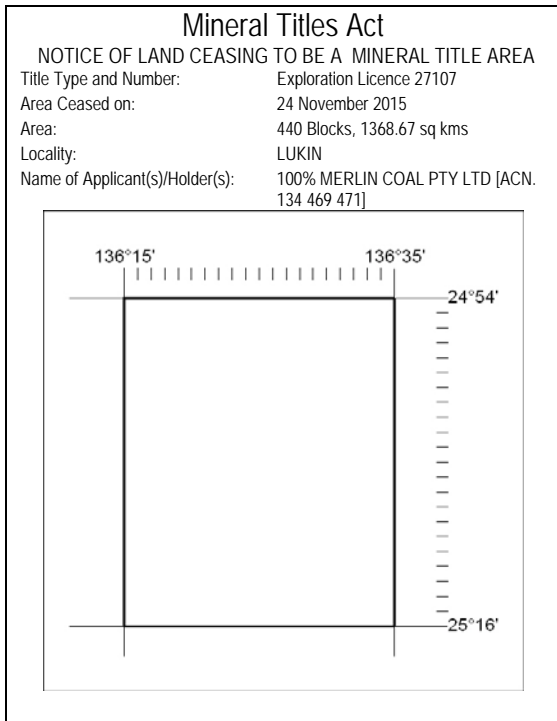

612/15

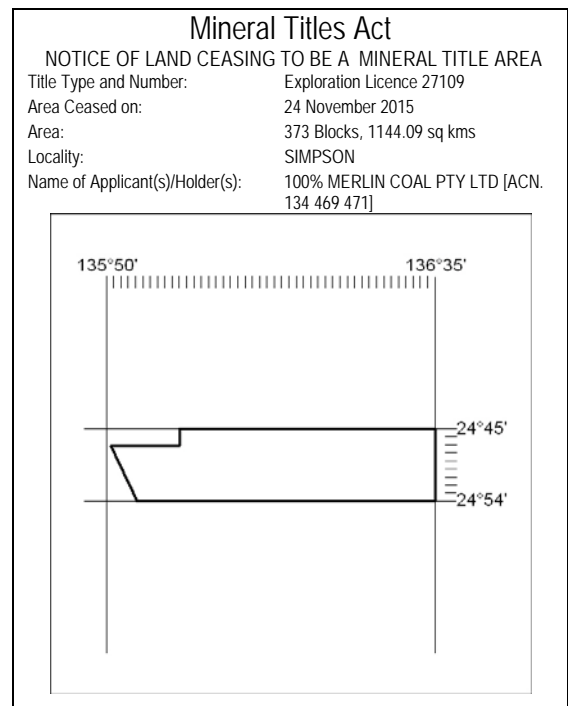

614/15

Mineral Titles Act

NOTICE OF LAND CEASING TO BE A MINERAL TITLE AREA

Title Type and Number: Exploration Licence 27110
 Area Ceased on: 24 November 2015
 Area: 180 Blocks, 561.09 sq kms
 Locality: HUBBARD
 Name of Applicant(s)/Holder(s): 100% MERLIN COAL PTY LTD [ACN. 134 469 471]

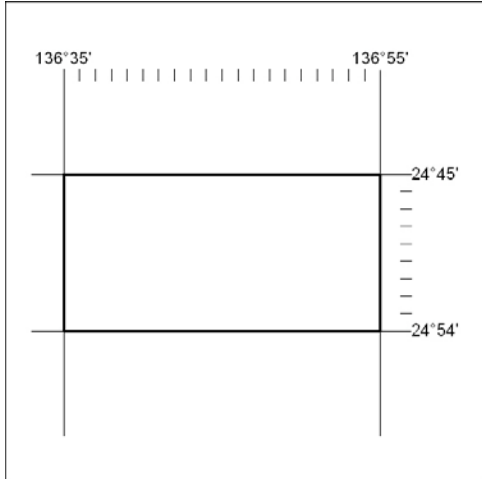

615/15

Mineral Titles Act

NOTICE OF LAND CEASING TO BE A MINERAL TITLE AREA

Title Type and Number: Exploration Licence 28095
 Area Ceased on: 24 November 2015
 Area: 420 Blocks, 1310.18 sq kms
 Locality: SIMPSON
 Name of Applicant(s)/Holder(s): 100% MERLIN COAL PTY LTD [ACN. 134 469 471]

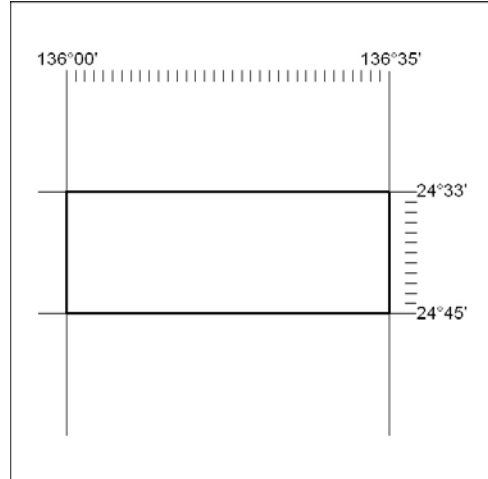

617/15

Mineral Titles Act

NOTICE OF LAND CEASING TO BE A MINERAL TITLE AREA

Title Type and Number: Exploration Licence 27114
 Area Ceased on: 24 November 2015
 Area: 480 Blocks, 1375.02 sq kms
 Locality: McDILLS
 Name of Applicant(s)/Holder(s): 100% MERLIN COAL PTY LTD [ACN. 134 469 471]

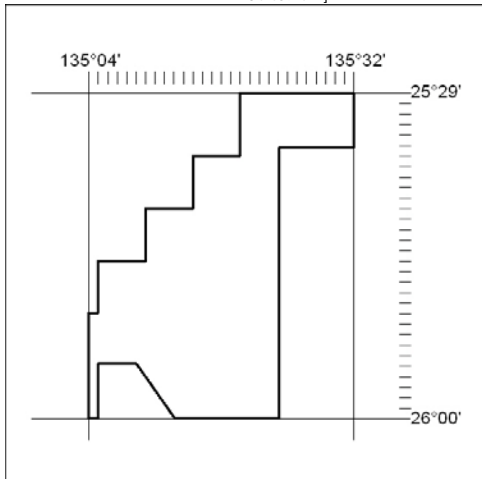

616/15

Mineral Titles Act

NOTICE OF LAND CEASING TO BE A MINERAL TITLE AREA

Title Type and Number: Exploration Licence 28096
 Area Ceased on: 24 November 2015
 Area: 240 Blocks, 749.17 sq kms
 Locality: HUBBARD
 Name of Applicant(s)/Holder(s): 100% MERLIN COAL PTY LTD [ACN. 134 469 471]

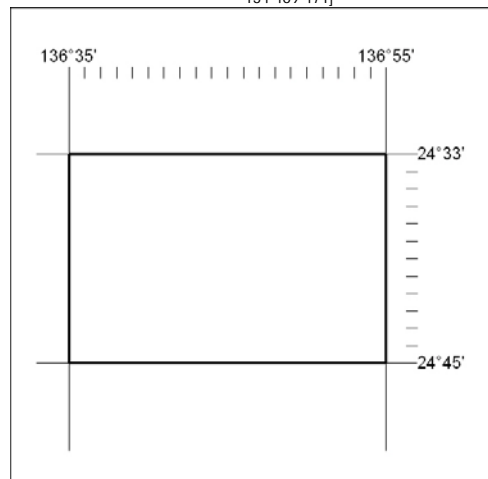

618/15

Mineral Titles Act

NOTICE OF LAND CEASING TO BE A MINERAL TITLE AREA

Title Type and Number: Exploration Licence 28097
 Area Ceased on: 24 November 2015
 Area: 364 Blocks, 1064.99 sq kms
 Locality: LANGLEY
 Name of Applicant(s)/Holder(s): 100% MERLIN COAL PTY LTD [ACN. 134 469 471]

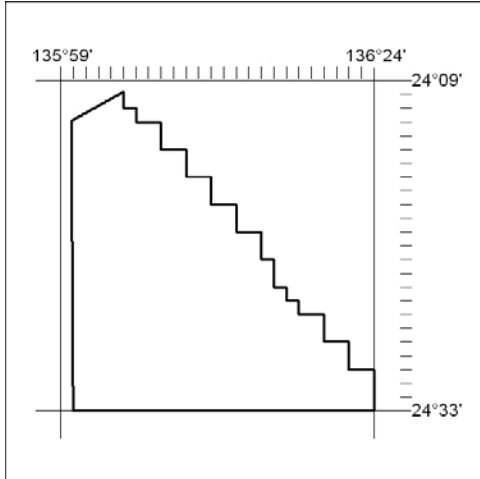

619/15

Mineral Titles Act

NOTICE OF LAND CEASING TO BE A MINERAL TITLE AREA

Title Type and Number: Exploration Licence 27965
 Area Ceased on: 24 November 2015
 Area: 12 Blocks, 38.47 sq kms
 Locality: MURRAY DOWNS
 Name of Applicant(s)/Holder(s): 100% AMI RESOURCES PTY LTD [ACN. 140 405 992]

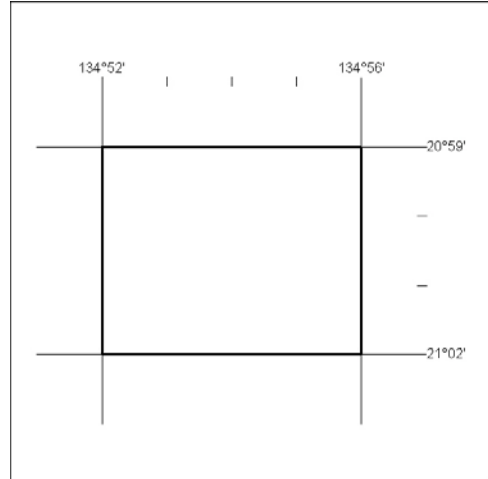

621/15

Mineral Titles Act

NOTICE OF LAND CEASING TO BE A MINERAL TITLE AREA

Title Type and Number: Exploration Licence 27264
 Area Ceased on: 24 November 2015
 Area: 249 Blocks, 772.51 sq kms
 Locality: JARVIS
 Name of Applicant(s)/Holder(s): 100% RED METAL LIMITED [ACN. 103 367 684]

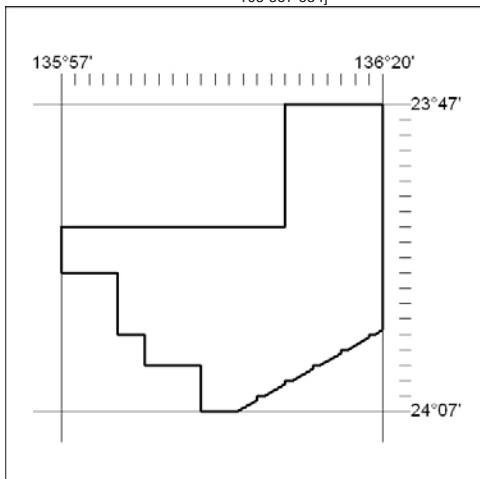

620/15

Mineral Titles Act

NOTICE OF LAND CEASING TO BE A MINERAL TITLE AREA

Title Type and Number: Exploration Licence 28535
 Area Ceased on: 24 November 2015
 Area: 11 Blocks, 36.07 sq kms
 Locality: SURPRISE CREEK
 Name of Applicant(s)/Holder(s): 100% REDBANK OPERATIONS PTY LTD [ACN. 109 362 165]

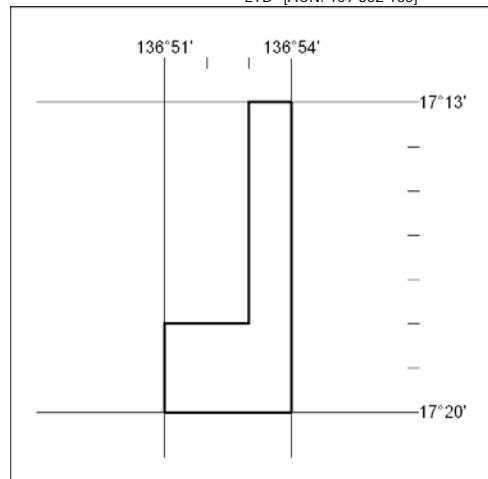

622/15

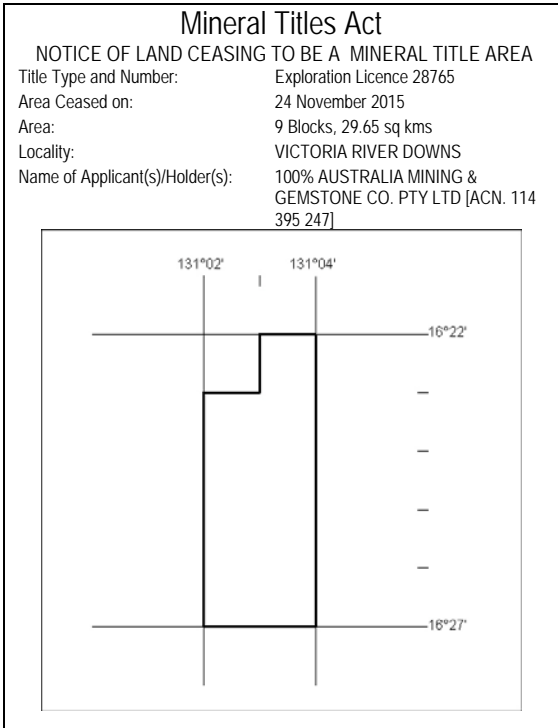

623/15

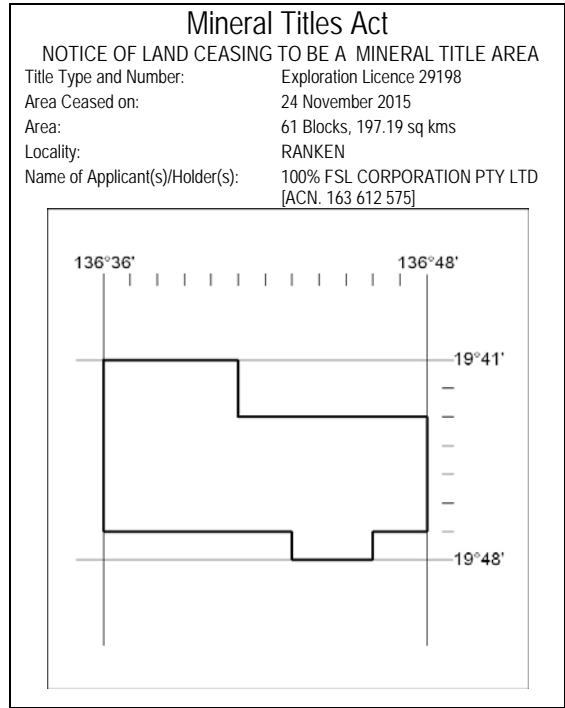

625/15

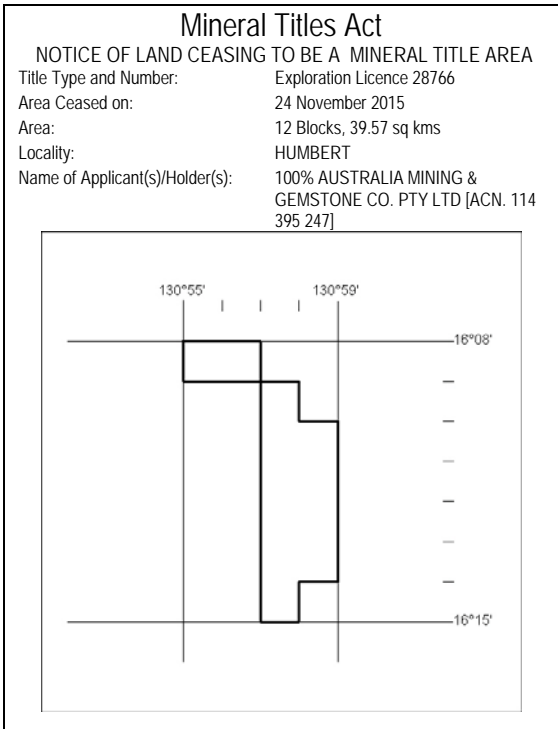

624/15

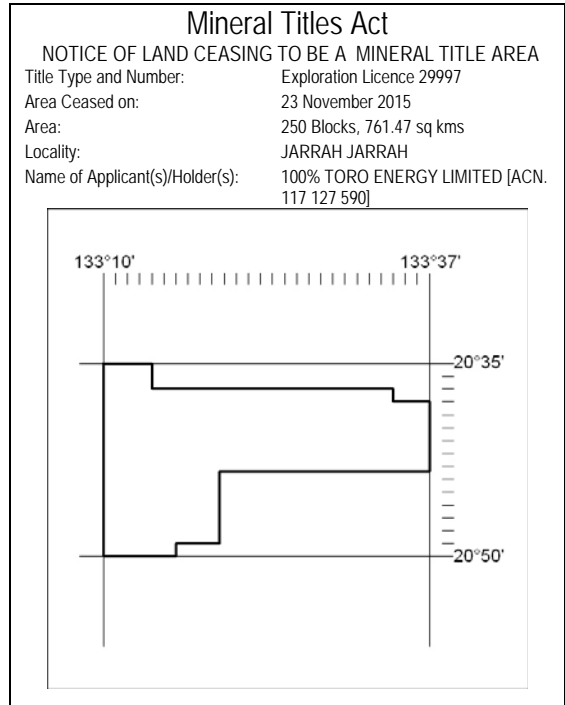

626/15

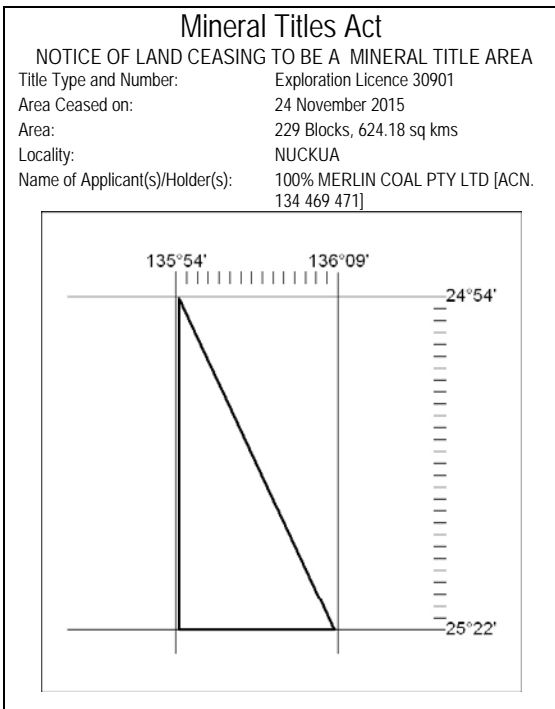

627/15

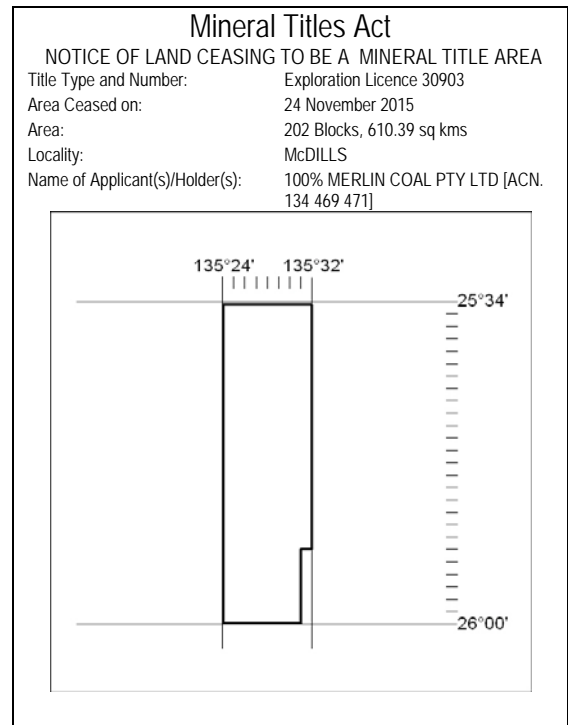

629/15

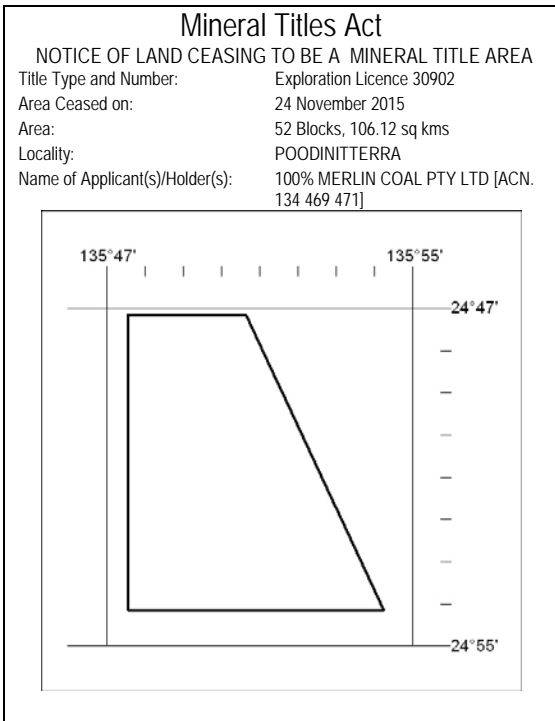

628/15

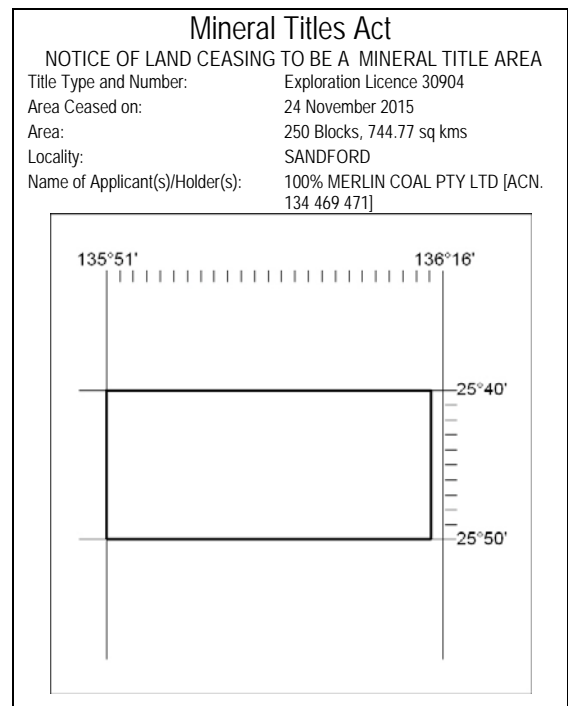

630/15

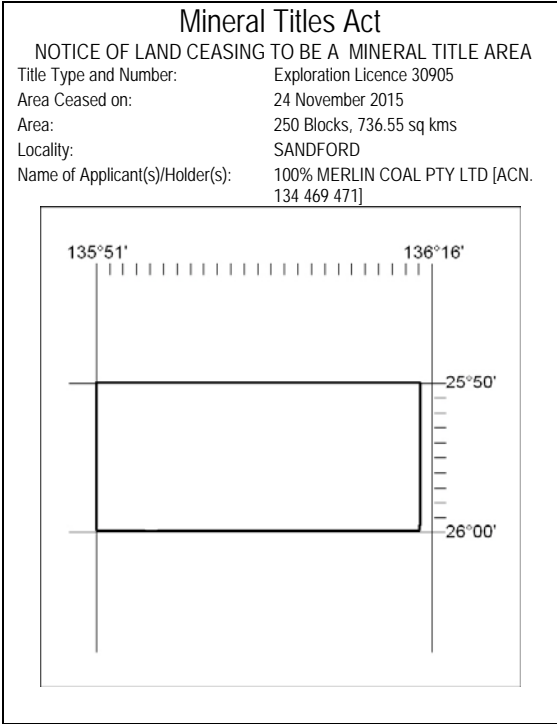

631/15

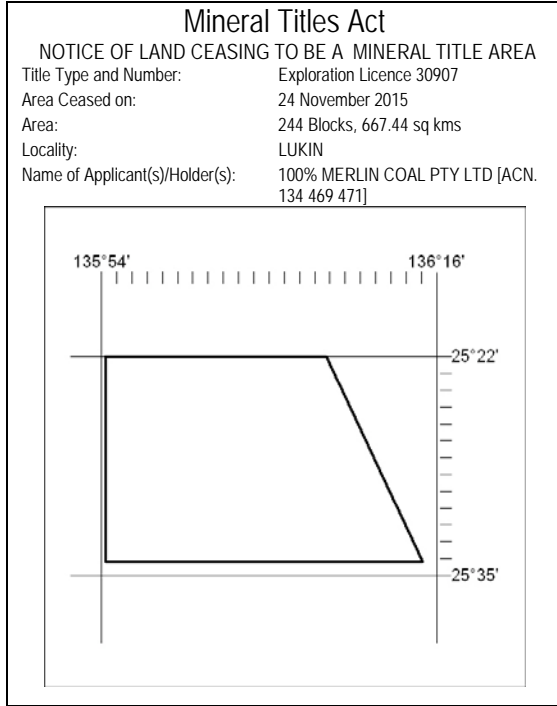

633/15

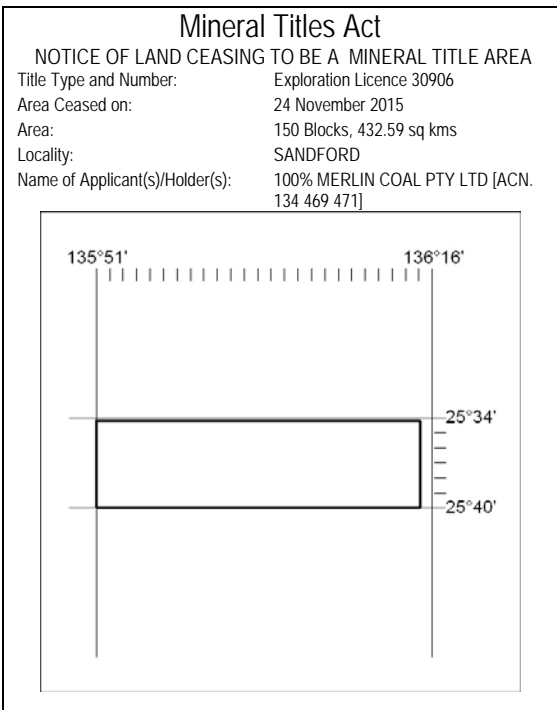

632/15